

Original operating manual for

ARIS Ex Actuators

Nano Ex and CL Ex

Type TA 130 LT

Electrical rotary drives for use in explosive atmospheres



Inhaltsverzeichnis

Identification.....	3
Nameplate	3
Guidelines and standards	4
Safety information.....	4
Warnings.....	4
General safety advices	4
Technical specification	5
Function and application areas (Intended use)	5
Safe and accurate use	5
Dimensions.....	7
Performance data.....	8
Expected lifespan and intended disposal	8
Actuator setup for use.....	8
Transport and (temporary) storage.....	8
Packaging	9
Safe disposal of packaging.....	9
Installation and mounting	9
Initial operation.....	10
Electrical connection.....	10
Wiring diagram Nano Ex.....	11
Wiring diagram CL Ex	11
Operation of the actuators	12
Set up rotation direction.....	12
Set up limit switches	12
Nano Ex	12
CL Ex.....	12
Optional modules and extra features.....	13
Potentiometer.....	13
Additional limit switches.....	13
2-wire-current output 4-20 mA.....	14
Required customer information	14
Extraordinary situations.....	14
Troubleshooting and repair	15
Maintenance.....	15
Service	15
Accessories	15
Spare parts.....	15

1. Identification

This manual is valid for:

Description: Electrical actuators for explosive atmospheres
Type: TA 130 LT with integrated ARIS actuators type Nano and CL
Serial no.: 1419-XXXXX-01001 ff.

1.1 Nameplate

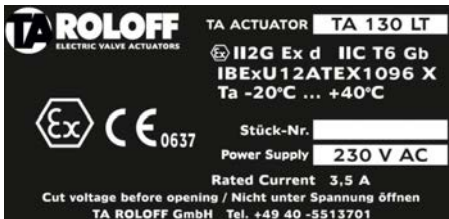

← Original manufacturer nameplate with ATEX labeling



Baureihe: Nano Ex, CL Ex
Fabr.-Nr.: JJKW-XXXXX-01001
10 Nm, 2,4s/90°
Stück-Nr.

← Additional nameplate with details of torque, actuating time and serial number

1.2 Guidelines and standards

ARIS actuators are partly completed machinery according to directive 2006/42/EC. This is certified by a declaration of incorporation (see page 16). These electrical actuators for explosive atmospheres comply with the basic safety and health requirements of the ATEX directive 94/9/EC in accordance with EN 60079-0:2009 and EN 60079-1:2007.

The complete identification of the actuator contains the following details:

 II 2G Ex d IIC T6 Gb

Further applicable EC directives:

EMC Directive 2004/108/EC

Applied harmonized standards:

LVD (electrical safety)
MachDir





DIN EN 61010-1:2011-07
DIN EN 12100:2011-03

2. Safety information

2.1 Warnings

Symbols: Installation and initial operation only by certified experts according to the manual.

Observe the significance of the following symbol and note explanations. They are subdivided in security levels and classified according to ISO 3864-2.

	DANGER indicates a hazard with a high risk degree, which, if not avoided, causes death or heavy injuries.
	WARNING indicates a hazard with a medium risk degree, which, if not avoided, can cause death or heavy injuries.
	CAUTION indicates a hazard with a low risk degree, which, if not avoided, can cause slight or moderate injuries.
	Indicates general advices, useful hints and work recommendations, which don't have influence on the safety and health of the staff.

2.2 General safety advices

This manual serves as basis to install and operate ARIS actuators safety conform. It is binding for transport, storage, installation, operation, maintenance and repair. Advices and warnings have to be observed.

All persons working with or on ARIS actuators must observe this manual and especially its safety advices.



- Working on electric appliances or equipment is only allowed for electrically qualified persons or other instructed persons under guidance and custody of an electrically qualified person according to the electro-technical regulations.
- Activities in explosive atmospheres are covered by special regulations which have to be observed. The plant operator or plant constructor is responsible for observing these regulations, standards and laws.

- Observe all safety and accident prevention regulations while installing, operating and testing any electrical appliances or machinery.
- Consult and observe the on-site safety regulations on decommission or maintenance/repair.
- Prior to all installation or regular work on the actuator make sure to switch off all connected machinery/appliances.
- Contact the supplier or manufacturer, if problems can not be solved by the manual.
- Any modifications to the actuators are strictly forbidden and lead to loss of the Ex-protection permit.

The manufacturer reserves the right for technical changes or improvements at any time.

Special conditions for a safe use

The rotary drive contains internal ignition sources according to EN 60079-14, section 10.4.2. For the electrical connection use only the connection wires and cable entries which are defined by the manufacturer and proofed with the actuator. Refer to chapter 3.4 „Performance data“.

 ADVICE	<ul style="list-style-type: none"> • This manual has to be kept at the operating place at any time. • Read the manual carefully prior to installation and initial operation.
 WARNING	<p>Certain parts of active electric appliances are obligatory under voltage.</p>

3. Technical specification

3.1 Function and application areas (Intended use)

ARIS actuators Nano Ex and CL Ex (Typ TA 130 LT) are exclusively designed for industrial use in explosive atmospheres according to their characterization. ARIS actuators are utilized for operating regulating and shut-off appliances (valves, ball valves, slide valves, dosing pumps etc.).

ARIS actuators Nano Ex und CL Ex (Typ TA 130 LT) may not be used for

- permanent underwater use,
- explosive atmospheres in zones 0 and 20,
- explosive atmospheres of group I (Mining),
- radiation exposed areas (nuclear plants),
- temperatures below -20 °C or above 40 °C,
- underground environments,
- near open fires.

3.2 Safe and accurate use

ARIS actuators are factory checked prior to delivery. The final functional testing must be performed within the total system by qualified technical personnel.

The ARIS company assumes no liability for possible manufacturing errors and resulting damages or subsequent damages after the actuator has been tested, installed and declared functional correct. The ARIS company especially assumes no liability for possible manufacturing errors and resulting damages or subsequent damages when the actuator was operated inappropriate, has not sufficiently been tested within the total system, or has not been put out of operation after a failure has determined during testing.

 **CAUTION**

Installation and initial operation only by qualified experts.

- Valves, levers and connecting rods are moving during actuator operation;
- Check for proper function of all emergency equipment on your machinery;
- Check for proper function of the actuator and operated valves after completion of all installation work.

 **WARNING**

Never work with or operate a faulty actuator!

Operation of actuators only with closed covers!

3.3 Dimensions

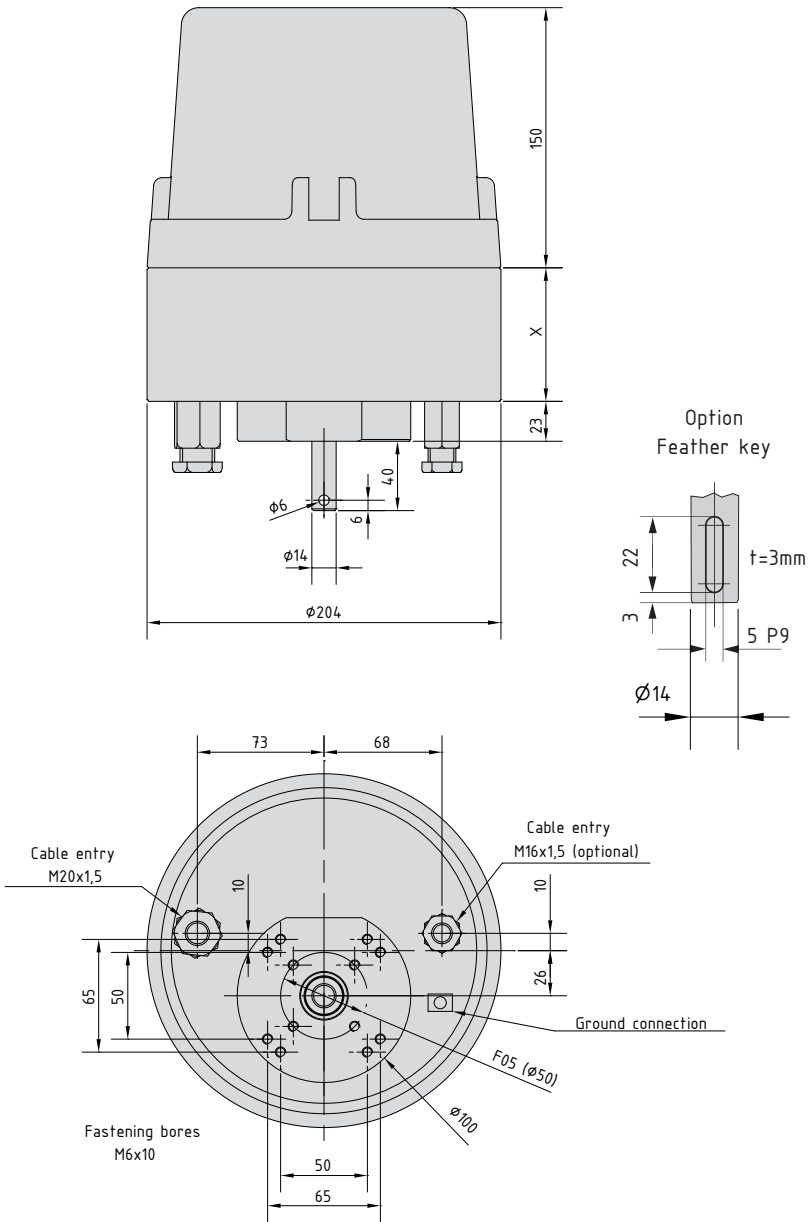

3.4 Performance data

- **Protection class: IP65**
- **Motor: 230V ±10%, 50/60Hz ±5%, 100% ED (Standard)**
 - » Special voltage/-frequency see nameplate (Option)
 - » Insulation class E acc. DIN EN 60034-1 (Nano Ex); Insulation class B acc. DIN EN 60034-1 (CL Ex)
- **Cable glands**

(Manufacturer: Schroll, Nymarken 27, 5330 Munkebo Denmark, ATEX approval: IBEU06ATEX1070):

Supply: 1 x M20x1.5 (Supply cable, control and additional switch: min. outer diameter: 11.0 mm; max. outer diameter: 14.2 mm)

Return: 1 x M16x1.5 (Return cable from poti, additional switches and set value output of control cards, 3-conductor, shielded: min. outer diameter: 3.5 mm; max. outer diameter: 8.5 mm)
- **Path cut-off: Changeover switch (Opener/Closer)**
 - » Switching capacity max. 10(3)A, 250V AC
- **Ambient temperature**
 - » -20 °C to +40 °C
- **Installation position: Arbitrary**
- **Potentiometer (Option)**
 - » Recommended wiper current: Nano Ex: 0.2 µA; CL Ex: 0.02 mA (RP19), < 2 µA (MP21)
 - » Capacity at +70 °C: Nano Ex: 0.5 W; CL Ex: 0.5 W (RP19), 1 W (MP21)
- **Travel: 10°...330°**



WARNING

According to EC type examination, section 17, the Ex protection is only valid with use of specified cable diameters.

3.5 Expected lifespan and intended disposal

ARIS actuators have an expected lifespan of several years, depending on their utilization and application. No longer usable actuators must not be dismantled as a whole, but separately recycled in parts divided by their materials. Non-recyclable components must be disposed according to national disposal regulations.

4. Actuator setup for use

4.1 Transport and (temporary) storage

Use the factory packaging for transport to the installation point.
Replace a damaged original packaging by a new solid packaging.



WARNING

Suspended load

Improper use of transportation (ground conveyer, overhead crane, tools, lifting means etc.) can cause crushes and other injuries.
Required behaviour:

- Use transportation properly;
- DO NOT step or stand under suspended loads;
- Actuators with attached valves: Attach lifting gear only on the valve and NEVER on the actuator;
- Do not use ARIS actuators as a climbing or support aid;



ADVICE

Damage by wrong storage.

- Store in well-ventilated rooms;
- Protection against possible ground humidity (shelf storage).

4.2 Packaging

ARIS actuators are protected by special cardboard packaging at delivery.

4.3 Safe disposal of packaging

Additionally necessary packaging is made by easily separable packaging materials and can be recycled individually:

- Wood
- Cardboard
- Paper
- Plastics

4.4 Installation and mounting



ADVICE

Conduct the following points prior to every initial operation:

- Inspect the actuator for damages prior to installation;
- the screw-in depth of connecting thread holes must not exceed 9 mm;
- check leak tightness of cable glands and blank plugs prior to initial operation;
- tighten the cover screws evenly (max. 1.2 Nm);
- do not operate before limit switches have been adjusted;
- protect the actuator against climatic influences (e.g. by a protective cover);
- do not expose the actuator to hard shocks (e.g. by dropping);
- do not attach ropes, hooks or the like to the actuator;
- permanent overload and blocking leads to actuator damages;
- spark suppressor capacitor can effect the rotation stability of the actuators and may cause damages;
- use only ARIS original spare parts.

Consider prior to attachment of couplings:

- Do not turn actuator shafts by force;
- actuator and valve shafts must run central (possible adjustment by flexible coupling);
- the attachment to the valve is made by actuator-attached brackets.

Installation position: The actuators can be installed position independently.



ADVICE

Protection class IP65

For all actuators observe the following advices:

The initial operation of the actuator is only permitted with orderly closed cover and closed cable entries. Use only cable glands which are appropriate for the respective protection class.

- **Cable entries**

Ensure that all cable entries are closed properly during storage, installation and initial operation.

Use only cables which are suitable for the diameter of the cable entries. See chapter 3.4 „Performance data“.

- **Cover assembly**

During the cover assembly make sure that the cover fits correctly.

The cover must not show any damages on the joint surface.

**ADVICE**

Tighten the cover screwing with the provided hook wrench.

- **Housing/Cover**

**CAUTION**

No additional bores are allowed in the housing and the cover.

4.5 Initial operation

4.5.1 Electrical connection

**DANGER**

Hazardous voltage: Possible stroke!

- The initial operation must be carried out only by experts!
- De-energize the actuator before opening.
- Observe the appropriate regulations during electrical installation and initial operation.

Connect the actuator as follows:

- Connect the ground wire of the electric supply to the appropriate protective earth terminal.
- Connect the neutral N to terminal 1.
- Follow the steps under „Set up rotation direction“ (S. 12) during connection of the actuator.
- Always refer to the wiring diagram located inside the actuator.

Check before you close the circuit for the first time:

- Is the actuator undamaged on the outside?
- Is the mechanical connection correct?
- Has the electrical connection been made regularly?
- Check if current type, voltage and frequency match with the motor data (see nameplate on cover and inside the actuator).
- Use separate (shielded) wires for low voltages (e.g. potentiometer).
- Set up limit switches prior to initial operation (see page 12).

! ADVICE

All elements, such as switches, potentiometer etc., are factory-wired. Never change the internal wiring (Loss of warranty).

4.5.2 Wiring diagram Nano Ex

- SL Limit switch, left-hand rotation
- SR Limit switch, right-hand rotation
- S1 Auxiliary switch 1
- S2 Auxiliary switch 2
- R1 Potentiometer 1

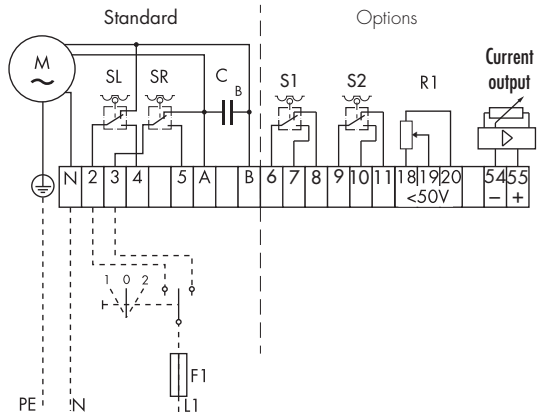

4.5.3 Wiring diagram CL Ex

- S1L Limit switch, left-hand rotation
- S2R Limit switch, right-hand rotation
- S3 Auxiliary switch 1
- S4 Auxiliary switch 2
- S5 Auxiliary switch 3 (Option)
- S6 Auxiliary switch 4 (Option)
- R1 Potentiometer 1
- R2 Potentiometer 2 (Option)
- HZ Heating
- M Current output (Option)
- K1 Relais for parallel operation

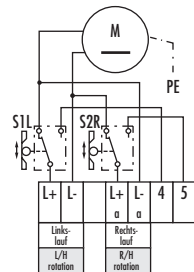
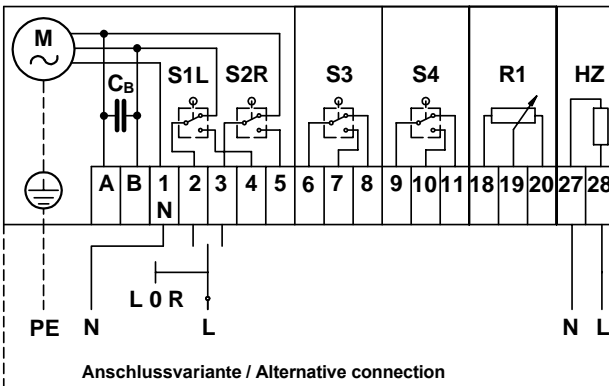
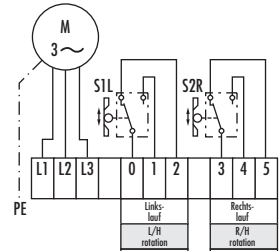

! ADVICE

All auxiliary switches must be operated within the same voltage range. Do not mix line voltage with low voltage.

5. Operation of the actuators

5.1 Set up rotation direction

Due to the internal wiring, the rotation direction (viewing direction is through the actuator towards the shaft) and the limit switches assign as follows:

- With line voltage on terminal 1 and 2, the actuator shaft rotates **counter-clockwise**. Limitation of this rotation direction with:
 - ▶ upper switch SL (**Nano Ex**)
 - ▶ lower limit switch S1L (**CL Ex**)
 When the switch is activated, line voltage is on terminal 4.
- With line voltage on terminal 1 and 3, the actuator shaft rotates **clockwise**. Limitation of this rotation direction with:
 - ▶ lower switch SR (**Nano Ex**)
 - ▶ second limit switch S2R (**CL Ex**)
 When the switch is activated, line voltage is on terminal 5.
- If the actuator runs counterrotating to the commands, change the external connection of terminal 2 and 3.

5.2 Set up limit switches

5.2.1 Nano Ex (Self-adjusting switch cam)

Die Schaltnocken lassen sich von Hand verdrehen und müssen nicht fixiert werden.

- Apply voltage (see page 11): Actuator rotates in given direction.
- Switch off voltage when the desired end position has reached (no blocking of gear).
- Turn switch cam L in rotating direction of the cam shaft E until limit path switch SL clicks.
- Set up switch cam R for contrary rotating direction as described under step 1–3.
- Check setup by moving the actuator again electrically and adjust if necessary.

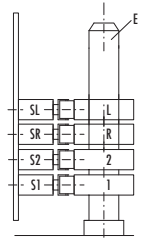

5.2.2 CL Ex

Depending on type, the switch cams may already be factory-adjusted to a switching position.

- Connect voltage for CCW rotation (AUF/OPEN). The actuator moves to the set direction.
- Depending on type, the shifting shaft rotates with or against the rotation of the driven shaft. Disconnect voltage when the desired end position has reached. **Attention: Gear must not block!**
- Turn S1L cam towards turning direction of the shifting shaft using the adjustment screw „J“ until the appropriate switch S1L „clicks“.
- Approach the end position electrically to check proper function and re-adjust if necessary.
- Set all other switches accordingly.

CW rotation

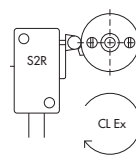

CCW rotation

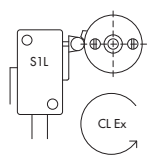

Adjustment screws J

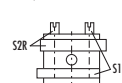

Adjustment screws J

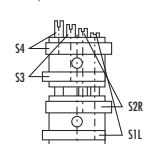

5.3 Optional modules and extra features

5.3.1 Potentiometer

Electrical connection

Connect terminals 18, 19 and 20 according to the desired requirements (voltage $\leq 50V$); (see page 11). Use only separate (shielded) wires.

Adjustment

Set up limit switch before adjusting the potentiometer P. Approach both end positions electrically (see chapter 5.2).

Observe travel and potentiometer solution.

Do not overrun the ordered travel to avoid damage to the friction clutch by permanent override. Potentiometer P adjust roughly automatically.

The travel of the valve is transferred to the rotating angle of the potentiometer by the friction clutch R. Approach both end positions again electrically (see page 15) and adjust potentiometer P with the friction clutch R.

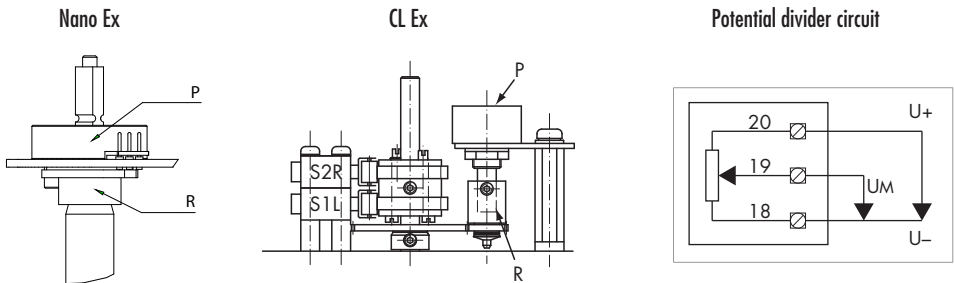

! ADVICE

All pots must generally run under a potential divider circuit.

5.3.2 Additional limit switches

1. Approach desired position. Switching position must be approached from the desired rotating direction.
2. Turn switch cams „1” resp. „2” (Nano Ex) resp. „3” and „4” (CL Ex) in rotating direction of the cam shaft E until limit switch „S1” resp. „S2” (Nano Ex) or „S3” resp. „S4” (CL Ex) clicks.
3. Check setup by moving the actuator again electrically and adjust if necessary.

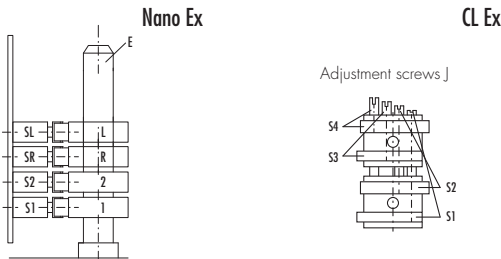

5.3.3 2-wire-current output 4-20 mA

Electrical connection

Connect terminal 54 and 55 according to the wiring diagram (see page 11).

! ADVICE

Use separate (shielded) wire with minimum diameter of 0.5 mm² and a max. length of 1000 m.

Setup

Operate the current output via buttons „4“ and „20“. Assigning arbitrary positions for 4 mA and 20 mA is possible at any time. The lower and upper current limit (4/20 mA) is programmed steady.

a) Assignment of end position 4 mA:

- Approach end position;
- press button „4“ more than 2 sec.;
- release button „4“;
- the end position is programmed and active at once.

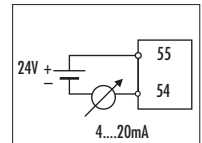

b) Assignment of end position 20 mA:

- Approach end position;
- press button „20“ more than 2 sec.;
- release button „20“;
- the end position is programmed and active at once.

6. Required customer information

6.1 Extraordinary situations

Run frequent testings during operation. Observe especially:

- Intended use of the actuator (chapter 3.1);
- unusual noise, heavy vibration or high temperatures;
- check screws for tight seat;
- check cable entries, cable glands and blank plugs for tight seat and possible leakiness;
- condition of electric wires.





! WARNING

If failure appear, set the actuator out of order and correct the error.

! ADVICE

If you can not correct the error, contact an ARIS service person.
More information under: www.stellantriebe.de

6.2 Troubleshooting and repair

	Troubleshooting only by experts, who have been authorized by the plant constructor or operator.
	Hazardous voltage: Possible stroke! <ul style="list-style-type: none">• Cut off voltage and check for gas-free environment before opening the actuator.• Never connect to voltage when actuator is opened!
	Moving parts at built-on valves: Possible bruise!
	Repairs are only allowed in the manufacturers factory or in authorized workshops. A repair on the ignition transmission resistant gaps may only conducted according to the constructional specifications given by the manufacturer. A repair according to the values on tables 1 and 2 of EN 60079-1 is not allowed.

7. Maintenance

7.1 Service

ARIS actuators of type Nano EX und CL Ex (Typ TA 130 LT) have a lifetime lubrication and are generally maintenance-free. We recommend a yearly functional testing and visual check.

	<ul style="list-style-type: none">• Flame-proof enclosure, risk of explosion!• Disconnect voltage and check for gas-free environment prior to opening the actuator.• Gap surfaces may not show any damages or dirt.• The cover may not be tilted while assembling.
--	---

7.2 Accessories (included)

For opening and closing the actuator's cover, use a hook wrench according to DIN 1810 Form A, nut outer diameter 205-220 mm.

7.3 Spare parts

	Order spare parts at aris@stellantriebe.de any time. Please always state the serial number of the actuator.
--	---



Declaration of Incorporation of partly completed machinery

according
EU directive 2006/42/EC Annex II B „Machinery Directive“

Herewith we declare, that the below mentioned incomplete machinery

Product description:	Elektrische Schwenk-, Dreh- und Linearantriebe
Product Types:	CL-S, CL-M, CL-L, CL H and identical

Fulfills the basic requirements of the annex I of the directive 2006/42/EC, if it applies to the appropriate order:

1.1.2; 1.1.3; 1.1.5; 1.3.4; 1.4.1; 1.4.2.1; 1.5.1; 1.5.2; 1.5.4; 1.5.6; 1.5.8; 1.5.9; 1.5.11; 1.6.4; 1.7.3; 1.7.4

The following harmonized standards were applied: DIN EN ISO 12100:2011-03 („Safety of machinery“)

The product is a partly completed machinery in accordance with Article 2 letter g of the Directive 2006/42/EG. The special technical documents according to annex VII part B have been created. For reasonable requests these documents can be sent electronically to the responsible authorities.

Regarding the outgoing electrical hazards of the partly completed machinery, the safety objectives of directive 2006/95/EC ("Low Voltage Directive") are complied in accordance with Annex I No. 1.5.1 of Directive 2006/42/EC. Applied harmonized standard:

DIN EN 61010-1:2011-07 ("Safety requirements for electrical equipment for measurement, control, Control and laboratory use ")

The initial operation of this incomplete machinery is only permitted, if it is approved that the facility or machinery in which it will be installed corresponds to the EC directive 2006/42/EC, if it applies.

Authorized representative for collection of relevant technical documents:

Claudio Usai
Quality and product safety
ARIS Antriebe und Steuerungen GmbH
Rotter Viehtrift 9
D-53842 Troisdorf

This declaration is invalid if the machinery is changed or rebuilt in a manner it was not designed for.

Troisdorf, 02. January 2014

C. Usai (Quality and product safety)



Declaration of Incorporation of partly completed machinery

according
EU directive 2006/42/EC Annex II B „Machinery Directive“

Herewith we declare, that the below mentioned incomplete machinery

Product description:	Electrical actuator
Product Types:	nano and identical

Fulfills the basic requirements of the annex I of the directive 2006/42/EC, if it applies to the appropriate order:

1.1.2.c,e; 1.1.3; 1.1.5; 1.3.4; 1.5.1; 1.5.2; 1.5.4; 1.5.5; 1.5.6; 1.5.8; 1.5.9; 1.5.11; 1.6.1; 1.6.4; 1.7.3; 1.7.4

The following harmonized standards were applied:

DIN EN ISO 12100:2011-03 („Safety of machinery“)

The product is a partly completed machinery accordance with Article 2 letter g of the Directive 2006/42/EG. The special technical documents according to annex VII part B have been created. For reasonable requests these documents can be sent electronically to the responsible authorities.

Regarding the outgoing electrical hazards of the partly completed machinery, the safety objectives of directive 2006/95/EC ("Low Voltage Directive") are complied with in accordance with Annex I No. 1.5.1 of Directive 2006/42/EC. Applied harmonized standard:

DIN EN 61010-1:2011-07 ("Safety requirements for electrical equipment for measurement, control, Control and laboratory use ")

The initial operation of this incomplete machinery is only permitted, if it is approved that the facility or machinery in which it will be installed corresponds to the EC directive 2006/42/EC, if it applies.

Authorized representative for collection of relevant technical documents:

Claudio Usai
Quality and product safety
ARIS Stellantriebe GmbH
Rotter Viehtrift 9
D-53842 Troisdorf

This declaration is invalid if the machinery is changed or rebuilt in a manner it was not designed for.

Troisdorf, 01. June 2014

C. Usai (Quality and product safety)



Declaration of Conformity

In accordance with

EC Directive 2004/108/EC „Elektromagnetic Compatibility“ (EMC-Dir)

Herewith we declare under our sole responsibility that the product

Description:	Electric actuator
Series:	nano
Type:	nano s and identical

developed, designed and manufactured by

Name:	ARIS Stellantriebe GmbH
Address:	Rotter Viehtrift, D - 53842 Troisdorf/Germany

to which this declaration refers to, with reference to the electromagnetic compatibility, is noncritical resp. safe and complies with the requirements of annex I of this directive.

Determined based on the „Guideline for application of the 2004/108/EC directive“, Bundesnetzagentur, dated 21.05.2007. A complete technical documentation is existing.

The product is a partly completed machinery accordance with Article 2 letter g of the Directive 2006/42/EG. The special technical documents according to annex VII part B have been created.

This declaration is invalid if the machinery is changed or rebuilt in a manner it was not designed for.

Troisdorf, 19.08.2014

i.V. C. Usai (Quality and Product Safety)



DECLARATION OF CONFORMITY

in accordance with

EC Directive 2004/108/EG „Electromagnetic Compatibility“ (EMC-Dir)

Herewith we declare under our sole responsibility that the product

Description:	Electric actuator
Type:	CL-S, CL-M, CL-L, CL-H and identical

developed, designed and manufactured by

Name:	ARIS Stellantriebe GmbH
Address:	Rotter Viehtrift, D - 53842 Troisdorf

to which this declaration refers to, is corresponding with the following normative documents:

EMC-Dir (Fault-free operation)	DIN EN 61000-6-2:2006-03
EMC-Dir (Transient emissions)	DIN EN 61000-6-3:2011-09 DIN EN 61000-3-2:2010-03 DIN EN 61000-3-3:2009-06

A complete technical documentation is available.

The appropriate EC manual is existent in original.

This declaration expires if the actuator is modified and the modification is not verified by ARIS or the product is not mounted conventionally.

Troisdorf 19.08.2014

i.V. C. Usai (Quality and Product Safety)

IBExU Institut für Sicherheitstechnik GmbH
An-Institut der TU Bergakademie Freiberg

[1] **EC-TYPE EXAMINATION CERTIFICATE**

according to Directive 94/9/EC, Annex III

(Translation)



[2] Equipment and Protective Systems intended for use in Potentially Explosive Atmospheres, **Directive 94/9/EC**

[3] EC-Type Examination Certificate Number: **IBExU12ATEX1096 X**

[4] Equipment: **Rotary Drive**
Type TA 130 LT

[5] Manufacturer: **TA Roloff GmbH**

[6] Address: **Adlerhorst 5**
22459 Hamburg
GERMANY

[7] The design of the equipment mentioned under [4] and any acceptable variations thereto are specified in the schedule to this EC-Type Examination Certificate.

[8] IBExU Institut für Sicherheitstechnik GmbH, Notified Body number 0637 in accordance with article 9 of the Directive 94/9/EC of the European Parliament and the Council of 23 March 1994, certifies that the equipment mentioned under [4] has been found to comply with the Essential Health and Safety Requirements relating to the design and construction of equipment intended for use in potentially explosive atmospheres given in Annex II to the Directive.
The test results are recorded in the test report IB-12-3-041 of 29 October 2012.

[9] Compliance with the Essential Health and Safety Requirements has been assured by compliance with EN 60079-0:2009 and EN 60079-1:2007.

[10] If the sign „X“ is placed after the certificate number, it indicates that the equipment is subject to special conditions for safe use specified under [17] in the schedule to this EC-Type Examination Certificate.

[11] This EC-Type Examination Certificate relates only to the design and construction of the specified equipment. If applicable, further requirements of this Directive apply to the manufacture and supply of this equipment.

[12] The marking of the equipment mentioned under [4] shall include the following:

II 2G Ex d IIC T6 Gb

IBExU Institut für Sicherheitstechnik GmbH
Fuchsmühlenweg 7 - 09599 Freiberg, GERMANY
☎ +49 (0)3731 3805-0 - 📠 +49 (0)3731 23650

Authorised certifications
-Explosion protection-

By order

(Dr. Wagner)



- Seal -
(ID no. 0637)

Freiberg, 29 October 2012

Certificates without signature and seal are not valid. Certificates may only be duplicated completely and unchanged. In case of dispute, the German text shall prevail.

Schedule

[13] **Schedule**

[14] **to the EC-TYPE EXAMINATION CERTIFICATE IBExU12ATEX1096 X**

[15] **Description of equipment**

The Rotary Drive type TA 130 LT serves as control unit for the operation of armatures, i. g. dampers, ball valves and valves. The flameproof enclosure consists of a cover and a bottom plate, which is attached on a gear case. The electrical units, as well as drive motors, micro switches, transformer, are placed in the flameproof enclosure. They are mounted on the bottom plate. The electric connection is carried out directly via Ex d cable entries.

Technical data:

- | | |
|------------------------------|--------------------------------|
| - Nominal voltage: | max. 400 V / 50 Hz or 220 V DC |
| - Nominal current: | max. 3.5 A |
| - Nominal power: | max. 100 W |
| - Torque: | max. 90 Nm |
| - Positioning time for 90°: | max. 65 s |
| - Ambient temperature range: | -20 °C up to +40 °C |

[16] **Test report**

The test results are recorded in the test report IB-12-3-041 of 29 October 2012. The test documents are listed in the annex to the test report.

Summary:

The Rotary Drive type TA 130 LT fulfils the requirements of explosion protection for equipment of Group II, Category 2G, type of protection Flameproof enclosure „d“ for explosive atmospheres of explosion group IIC and up to temperature class T6.

[17] **Special conditions for safe use**

- Repairs of the flameproof joints must be made in compliance with the constructive specifications provided by the manufacturer. Repairs must not be made on the basis of values specified in tables 1 and 2 of EN 60079-1.
- The Rotary Drive contains internal sources of ignition according to EN 60079-14, Paragraph 10.4.2. The cables and cable entries selected by the manufacturer and tested with the Rotary Drive have to be used for the electrical connection.

[18] **Essential Health and Safety Requirements**

Confirmed by compliance with standards (see [9]).

By order

Freiberg, 29 October 2012



(Dr. Wagner)

Subject to technical changes.

ARIS Stellantriebe GmbH
Rotter Viehtrift 9
53842 Troisdorf / Germany

Tel.: +49 2241 25186-0
Fax: +49 2241 25186-99
aris@stellantriebe.de

www.stellantriebe.de

