

Original declaration of
incorporation with manual for

ARIS actuator Nano

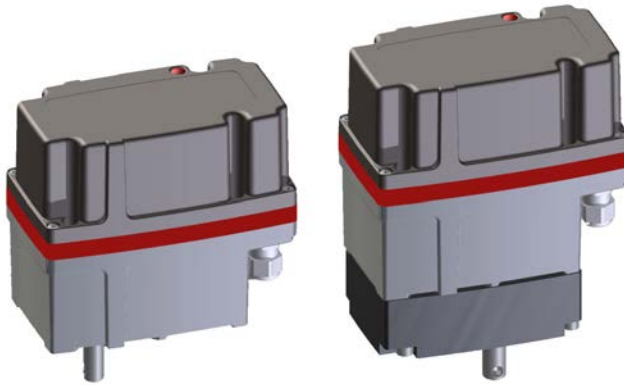

incl. operating manual for

ARIS Microprocessor-Controller PMR-Nano

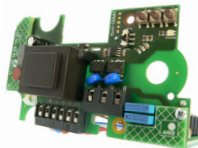

<u>Inhaltsverzeichnis</u>	
Identification	3
Nameplate	3
Guidelines and standards	4
Safety information.....	4
Warnings.....	4
General safety advices	4
Technical specification	5
Function and application areas (Intended use)	5
Safe and accurate use	5
Dimensions.....	6
Performance data	8
Expected lifespan and intended disposal	8
Actuator setup for use.....	8
Transport and (temporary) storage.....	8
Packaging	9
Safe disposal of packaging.....	9
Installation and mounting	9
Initial operation	10
Electrical connection.....	10
Wiring diagram	11
Operation of the actuators	11
Set up rotation direction.....	11
Set up limit switches (Self-adjusting switch cam).....	12
Optional modules and extra features.....	12
Potentiometer	12
Potentiometer with fixed shaft coupling.....	12
Potentiometer with approval acc. to DIN EN 12067-2 (TÜV-Poti).....	13
Additional limit switches (Self-adjusting switch cam)	14
2-wire-current output 4-20 mA.....	14
Mechanical position indicator.....	15
Service switch (230 V AC only)	15
Heating resistant (230 V AC only).....	15
Single wire control (230 V AC only)	16
Parallel relay (230 V AC only).....	16
Power supply 24 V DC (Special edition).....	17
Required customer information	17
Extraordinary situations.....	17
Troubleshooting and repair	18
Maintenance.....	18
Service	18
Accessories	18
Spare parts.....	18

1. Identification

This manual is valid for:

Description: Electric actuator
Type: Nano S / Nano M
Serial no.: 1419-xxxxx-01001 ff.

1.1 Nameplate

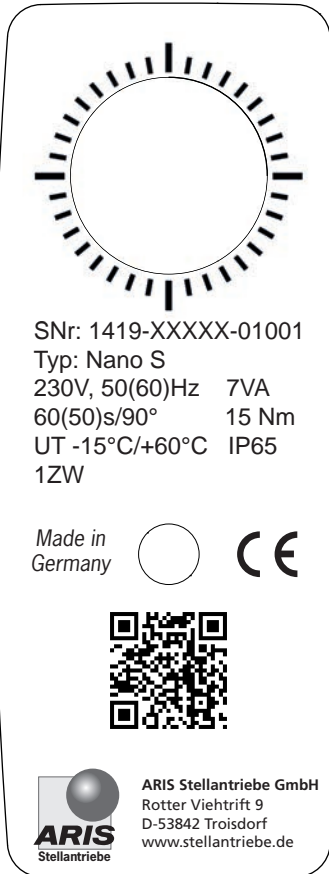

← Mechanical position indicator

← Serial number

← Actuator type

← Voltage/Frequency/Power consumption

← Actuating time/Torque

← Ambient temperature/Protection class

← Additional built-in parts

1.2 Guidelines and standards

ARIS actuators are partly completed machinery according to directive 2006/42/EC. This is certified by a declaration of incorporation (see page 14).

Further applicable EC directives:	EMC Directive 2004/108/EC	
Applied harmonized standards:	LVD (electrical safety) MachDir EMC Directive 2004/108/EC	DIN EN 61010-1:2011-07 DIN EN 12100:2011-03 DIN EN 61000-3-2 DIN EN 61000-3-3 DIN EN 61000-6-2 DIN EN 61000-6-3 DIN EN 55011:2001-04 DIN EN 61000-6-4:2011-09
Protection classes by housing (IP-Codes):	Protection class test	DIN EN 60529:1991



EMC consideration of the complete plant and system perturbations and their combating have to be carried out by the plant builder or operator. The wiring of the actuator should comply with DIN EN 60204-1.

2. Safety information

2.1 Warnings

Symbols: Installation and initial operation only by certified experts according to the manual.

Observe the significance of the following symbol and note explanations. They are subdivided in security levels and classified according to ISO 3864-2.

	DANGER indicates a hazard with a high risk degree, which, if not avoided, causes death or heavy injuries.
	WARNING indicates a hazard with a medium risk degree, which, if not avoided, can cause death or heavy injuries.
	CAUTION indicates a hazard with a low risk degree, which, if not avoided, can cause slight or moderate injuries.
	Indicates general advices, useful hints and work recommendations, which don't have influence on the safety and health of the staff.

2.2 General safety advices

The actuator components are conform to the state of the art and apply as generally safe at the time they are shipped.

This manual serves as basis to install and operate ARIS actuators safety conform. All persons working with or on ARIS actuators must observe this manual and especially its safety advices.

 **ADVICE**

- This manual has to be kept at the operating place at any time.
- Read the manual carefully prior to installation and initial operation.

 **WARNING**

Certain parts of active electric appliances are obligatory under voltage.

- Working on electric appliances or equipment is only allowed for electrically qualified persons or other instructed persons under guidance and custody of an electrically qualified person according to the electro-technical regulations.
- Observe all safety and accident prevention regulations while installing, operating and testing any electrical appliances or machinery.
- Prior to all installation or regular work on the actuator make sure to switch off all connected machinery/appliances.

3. Technical specification

3.1 Function and application areas (Intended use)

ARIS actuators are exclusively designed for industrial use. ARIS actuators are utilized for operating regulating and shut-off appliances (valves, ball valves, slide valves, dosing pumps etc.).

ARIS actuators may not be used for:

- Potentially explosive atmospheres
- Temperatures below -15 °C or over 60 °C (optional $+80\text{ °C}$)
- Underground environments
- Near open fires
- Under water

3.2 Safe and accurate use

ARIS actuators are factory checked prior to delivery. The final functional testing must be performed within the total system by qualified technical personnel.

The ARIS company assumes no liability for possible manufacturing errors and resulting damages or subsequent damages after the actuator has been tested, installed and declared functional correct. The ARIS company especially assumes no liability for possible manufacturing errors and resulting damages or subsequent damages when the actuator was operated inappropriate, has not sufficiently been tested within the total system, or has not been put out of operation after a failure has determined during testing.

 **VORSICHT**

Installation and initial operation only by qualified experts.

- Valves, levers and connecting rods are moving during actuator operation;
- Check for proper function of all emergency equipment on your machinery;
- Check for proper function of the actuator and operated valves after completion of all installation work;
- Never work with or operate a faulty actuator.

3.3 Dimensions

Nano S

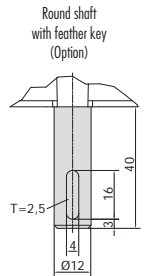
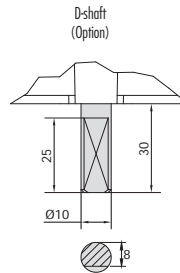
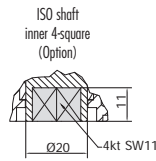
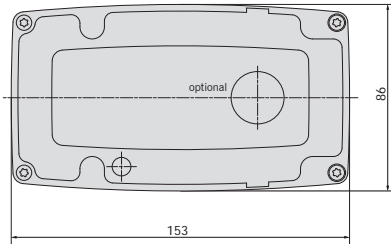
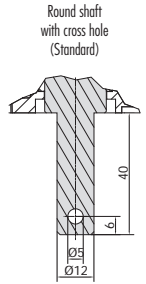
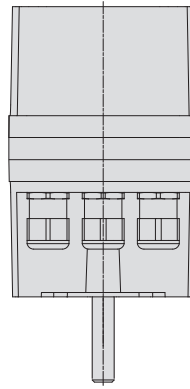
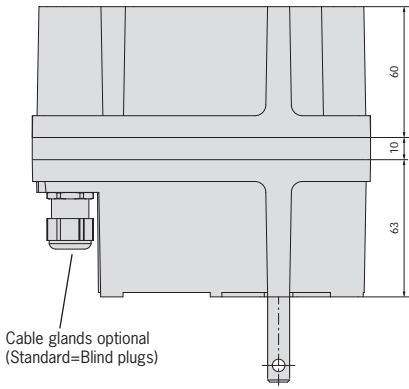
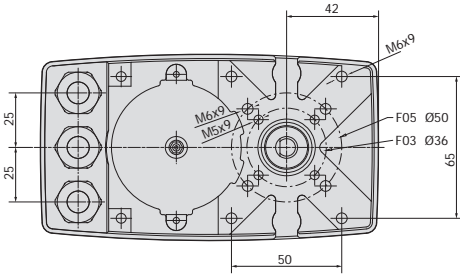

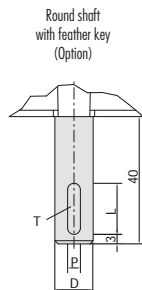
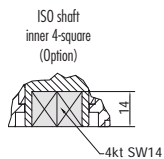
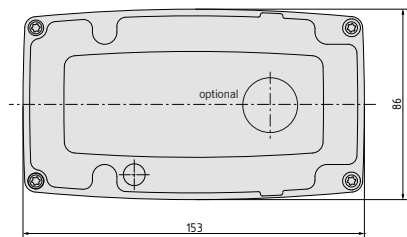
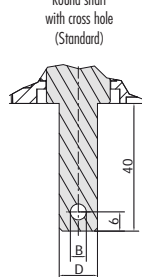
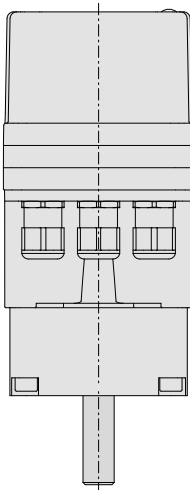
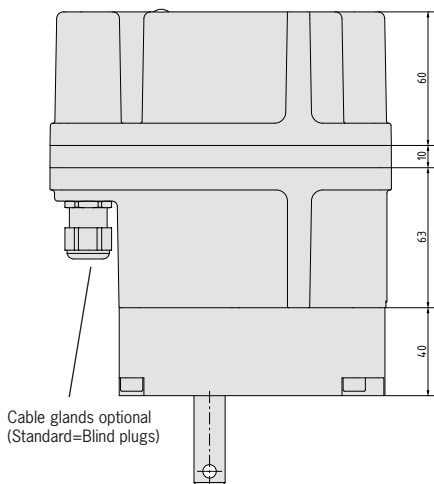
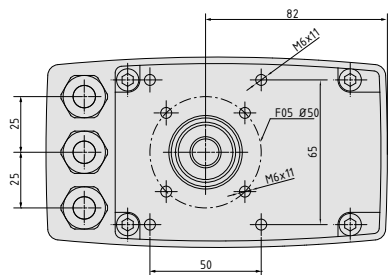

Typ	D	B	L	P	T
30 bis 40 Nm	12	5	16	4	2.5
50 bis 60 Nm	14	6	22	5	3

3.4 Performance data

- **Protection class: IP65 (optional IP66, IP67)**
- **Motor: 230V ±10%, 50/60Hz ±5%, 100% ED (standard)**
 - » Special voltage/-frequency see nameplate (Option)
 - » Insulation class E acc. DIN EN 60034-1
- **Motor: 24 V DC (Option) ±20%, ED S3 50%**
 - » Insulation class B acc. DIN EN 60034-1
- **Connection: 3 cable glands M16x1.5 (customer provided), M20x1.5 (option)**
- **Path cut-off: Changeover switch (opener/closer)**
 - » Switching capacity max. 10(3)A, 250V AC
- **Ambient temperature**
 - » -15 °C up to +60 °C (optional +80 °C)
- **Installation position: Arbitrary**
- **Potentiometer (Option)**
 - » Recommended wiper current: 0,2 µA
 - » Capacity at +70 °C: 0,5 W
- **Travel: 10°...330°**

3.5 Expected lifespan and intended disposal

ARIS actuators have an expected lifespan of several years, depending on their utilization and application. No longer usable actuators must not be dismantled as a whole, but separately recycled in parts divided by their materials. Non-recyclable components must be disposed according to national disposal regulations.

4. Actuator setup for use

4.1 Transport and (temporary) storage

Use the factory packaging for transport to the installation point.
Replace a damaged original packaging by a new solid packaging.



WARNING

Suspended load

Improper use of transportation (ground conveyer, overhead crane, tools, lifting means etc.) can cause crushes and other injuries.
Required behaviour:

- Use transportation properly;
- DO NOT step or stand under suspended loads;
- Actuators with attached valves: Attach lifting gear only on the valve and NEVER on the actuator;
- Do not use ARIS actuators as a climbing or support aid;



ADVICE

Damage by wrong storage

- Store in well-ventilated rooms;
- Protection against possible ground humidity (shelf storage).

4.2 Packaging

ARIS actuators are protected by special cardboard packaging at delivery.

4.3 Safe disposal of packaging

Additionally necessary packaging is made by easily separable packaging materials and can be recycled individually:

- Wood
- Cardboard
- Paper
- Plastics

4.4 Installation and mounting

- Inspect the actuator for damages prior to installation;
- the screw-in depth of connecting thread holes must not exceed 9 mm;
- check leak tightness of cable glands and blank plugs prior to initial operation;
- tighten the cover screws evenly (max. 1.2 Nm);
- do not operate before limit switches have been adjusted;
- protect the actuator against climatic influences (e.g. by a protective cover);
- do not expose the actuator to hard shocks (e.g. by dropping);
- do not attach ropes, hooks or the like to the actuator;
- permanent overload and blocking leads to actuator damages;
- spark suppressor capacitor can effect the rotation stability of the actuators and may cause damages;
- use only ARIS original spare parts.

Consider prior to attachment of couplings:

- Do not turn actuator shafts by force;
- actuator and valve shafts must run central (possible adjustment by flexible coupling);
- the attachment to the valve is made by actuator-attached brackets.

Installation position: The actuators can be installed position independently.



ADVICE

Protection classes IP65 (optional IP66, IP67)

For all actuators observe the following advices:

The initial operation of the actuator is only permitted with orderly closed cover and closed cable entries. Use only cable glands which are appropriate for the respective protection class.

- Cable entries
Ensure that all cable entries are closed properly during storage, installation and initial operation.
Use only cables which are suitable for the diameter of the cable entries.

- **Cover assembly**
During the cover assembly make sure that the cover fits correctly.
The cover must not show any damages on the joint surface.
Tighten cover screws evenly (max. 1.2 Nm).
- **Housing/Cover**



No additional bores are allowed in the housing and the cover.

4.5 Initial operation

4.5.1 Electrical connection



Hazardous voltage: Possible stroke!

- The initial operation must be carried out only by experts!
- De-energize the actuator before opening.
- Observe the appropriate regulations during electrical installation and initial operation.

Connect the actuator as follows:



The wire diameter must be designed according to the respective power consumption of the actuator and the required cable length. The nominal wire sizes for actuators of the Nano series are min. 0.5 mm² and max. 2,5 mm².

Too small wire diameter can often be the cause of malfunctions!

- Connect the ground wire of the electric supply to the appropriate protective earth terminal.
- Connect the neutral N to terminal N.
- Follow the steps under „Set up rotation direction“ (S. 10) during connection of the actuator.
- Always refer to the wiring diagram located inside the actuator.

Check before you close the circuit for the first time:

- Is the actuator undamaged on the outside?
- Is the mechanical connection correct?
- Has the electrical connection been made regularly?
- Check if current type, voltage and frequency match with the motor data (see nameplate on cover and inside the actuator).
- Insert suitable cable glands for the connection line.
- Observe the wiring diagram inside the cover.
- Use separate (shielded) wires for low voltages (e.g. potentiometer).
- Set up limit switches prior to initial operation (see page 11).



All elements, such as switches, potentiometer etc., are factory-wired.
Never change the internal wiring.

! ADVICE

In ARIS actuators no protection against defects in power circuit is available. Required fuses and disconnector switches must be planned and used. The current values for respective sizing is derived from the power consumption of the motor (s. Nameplate).

4.5.2 Wiring diagram

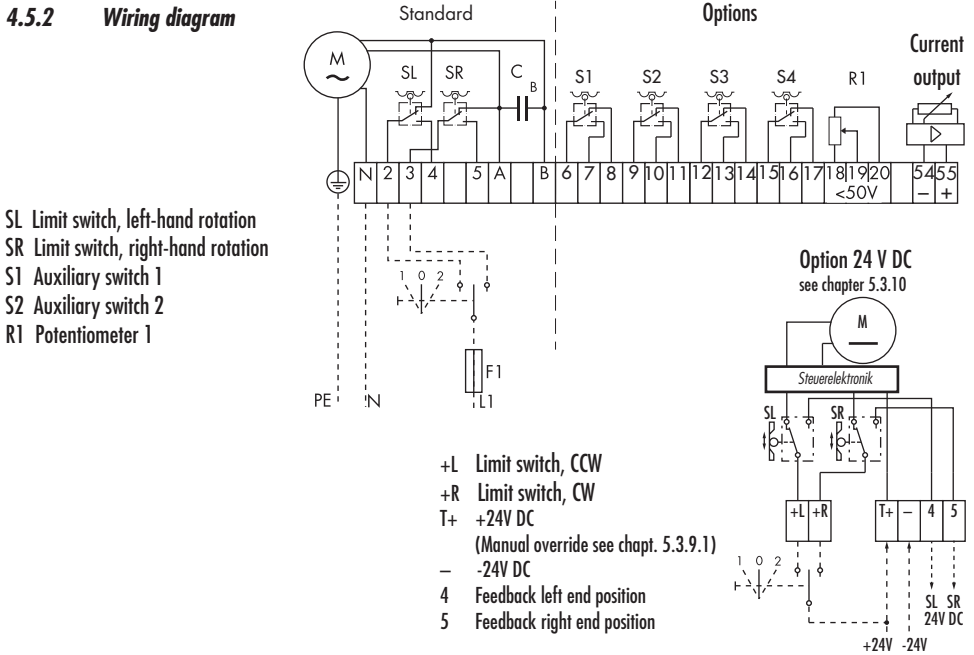

! ADVICE

All auxiliary switches must be operated within the same voltage range. Do not mix line voltage with low voltage.

5. Operation of the actuators

5.1 Set up rotation direction

Due to the internal wiring, the rotation direction (viewing direction is through the actuator towards the shaft) and the limit switches assign as follows:

1. With line voltage on terminal 1 and 2, the actuator shaft rotates **counter-clockwise**. Limitation of this rotation direction with upper switch SL. When the switch is activated, line voltage is on terminal 4.
2. With line voltage on terminal 1 and 3, the actuator shaft rotates **clockwise**. Limitation of this rotation direction with lower switch SR. When the switch is activated, line voltage is on terminal 5.
3. If the actuator runs counterrotating to the commands, change the external connection of terminal 2 and 3.

! ADVICE

Depending on the model, limit switches may be arranged different than drawn in the wiring diagram (see wiring diagram inside the actuator).

5.2 Set up limit switches (Self-adjusting switch cam)

The switch cams are turnable by hand and do not have to be fastened.

1. Apply voltage (see page 10): Actuator rotates in given direction.
2. Switch off voltage when the desired end position has reached (no blocking of gear).
3. Turn switch cam L in rotating direction of the cam shaft E until limit path switch SL clicks.
4. Set up switch cam R for contrary rotating direction as described under step 1–3.
5. Check setup by moving the actuator again electrically and adjust if necessary.

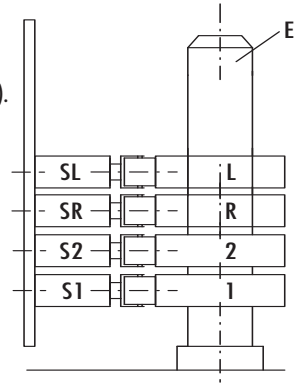

5.3 Optional modules and extra features

5.3.1 Potentiometer

Electrical connection

Connect terminals 18, 19 and 20 according to the desired requirements (voltage $\leq 50V$); (see page 10). Use only separate (shielded) wires.

Adjustment

Set up limit switch before adjusting the potentiometer P. Approach both end positions electrically (see chapter 5.2).

Observe travel and potentiometer solution.

Do not overrun the ordered travel to avoid damage to the friction clutch by permanent override. Potentiometer P adjust roughly automatically.

The travel of the valve is transferred to the rotating angle of the potentiometer by the friction clutch R. Approach both end positions again electrically (see page 15) and adjust potentiometer P with the friction clutch R.

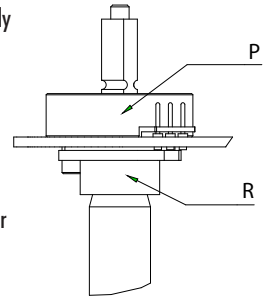

5.3.2 Potentiometer with fixed shaft coupling

Adjustment

Setting the path limit switch before adjusting the potentiometer P. Approach both limit positions electrically (see Section 5.2). Note the travel and potentiometer resolution. To fix the position tighten the two thread pins after setting the potentiometer by using the supplied Allen key. The ordered travel range must not be exceeded, otherwise a damage to the clutch R and the potentiometer can not be excluded.

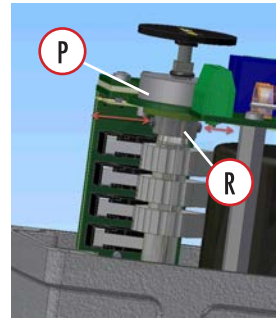

5.3.3 Potentiometer with approval acc. to DIN EN 12067-2 (TÜV-Poti)

Fail-safe potentiometer return for regulation of fuel, air and exhaust streams in combination with electronic compound control systems.

! ADVICE

At the installation of a regulation valve a consistently positive mechanical connection between the output shaft of the actuator with the valve shaft must be ensured.

At delivery the wiper is in the electrical center.

Overview TÜV-Poti

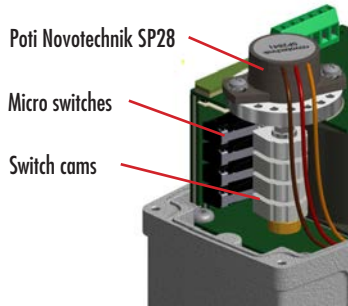

! ADVICE

The in the actuators optional built in additional auxiliary limit switches must not be used for safety-related position feedback.

Electrical connection

Connect terminals 18, 19 and 20 according to the desired needs (voltage $\leq 50V$); (see page 11). Use only separate, shielded wires.

Adjustment

Set the limit switch prior to adjustment of the potentiometers SP28. Electrically drive towards both end positions (see chapter 5.2). Match both travel and potentiometer resolution.

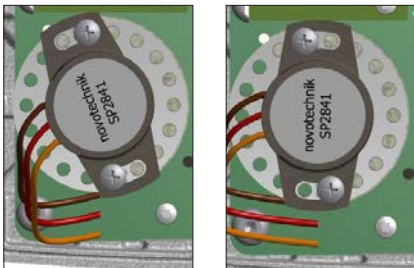

Fig. 1:
Poti adjustment up to 20°: Adjustment within the long holes. No move of screws necessary.

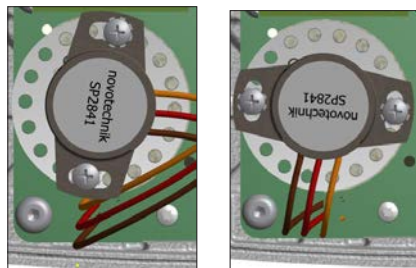

Fig. 2:
Poti adjustment 20° to 360°: Screws must be moved.

Within the long holes, the poti can be rotated up to 20° per hole (Fig. 1). If a rotation of more than 20° is necessary, the poti fastening screws are moved to the next hole. Then poti kann be moved in 20° steps up to 360° (Fig. 2). Fasten the screws with a torque of 1.8 Nm.

! ADVICE

It is mandatory that the factory-set TufLok screws must be used after loosening. Recommendation: Secure the poti fastening screws with thread-lock fluid.

! ADVICE

All potis must generally run under a potential divider circuit.

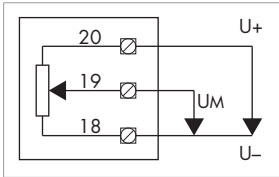

5.3.4 Additional limit switches (Self-adjusting switch cam)

1. Approach desired position. Switching position must be approached from the desired rotating direction.
2. Turn switch cams „1“ resp. „2“ in rotating direction of the cam shaft E until limit switch „S1“ resp. „S2“ clicks.
3. Check setup by moving the actuator again electrically and adjust if necessary.

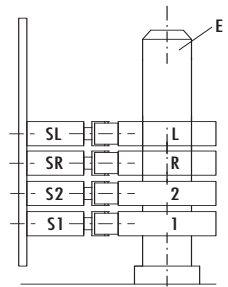

5.3.5 2-wire-current output 4-20 mA

Electrical connection

Connect terminal 54 and 55 according to the wiring diagram (see page 10). Use separate (shielded) wire with minimum diameter of 0.5 mm² and a max. length of 1000 m.

Setup

Operate the current output via buttons „4“ and „20“. Assigning arbitrary positions for 4 mA and 20 mA is possible at any time. The lower and upper current limit (4/20 mA) is programmed steady.

a) Assignment of end position 4 mA:

- Approach end position;
- press button „4“ more than 2 sec.;
- release button „4“;
- the end position is programmed and active at once.

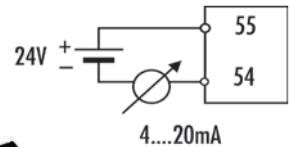

b) Assignment of end position 20 mA:

- Approach end position;
- press button „20“ more than 2 sec.;
- release button „20“;
- the end position is programmed and active at once.



5.3.6 Mechanical position indicator

The mechanical position indicator serves as a reference for the shaft position on the sight-glass and it is adjustable.

Adjustment: Adjust the mechanical position indicator by turning the angle pointer (marked with an arrow) and the enclosed arrow labels.



Ratio position indicator to valve position on Nano M: **The ratio at Nano S is always 1 : 1**

Type	Pos.ind. at 90°	Type	Pos.ind. at 90°	Type	Pos.ind. at 90°	Type	Pos.ind. at 90°
M 30-06	193.5°	M 40-09	288°	M 50-20	288°	M 60-20	288°
M 30-12		M 40-12	193.5°	M 50-50		M 60-50	
M 30-30		M 40-30	193.5°	M 50-90		M 60-90	
M 30-60		M 40-60	193.5°	M 50-180		M 60-180	
M 30-120		M 40-120	193.5°				

5.3.7 Service switch (230 V AC only)

Adjusting and service work can be done by using the service switch.

Operation:

Set the switch „SW2“ to „INT“ „Manual operation“. The actuator can now be moved via the switch „SW1“ left (position „L“) or right (position „R“).

For operation by an external controller, set the switch „SW2“ to „EXT“. Switch „SW1“ is without function now.

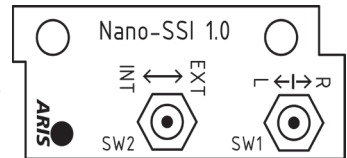

5.3.8 Heating resistant (230 V AC only)

Heating element for use of actuators in cold-humid environments. To avoid condensation water inside the actuator at fluctuating temperatures.



! ADVICE

The heater resistant is wired at factory. Never change the internal wiring. Observe the wiring diagram inside the actuator cover.

5.3.9 Single wire control (230 V AC only)

For use as open/close regulation by external controller or switching appliances with normally open or break contact. The rotation direction reverse is made by a built-in switching relay.

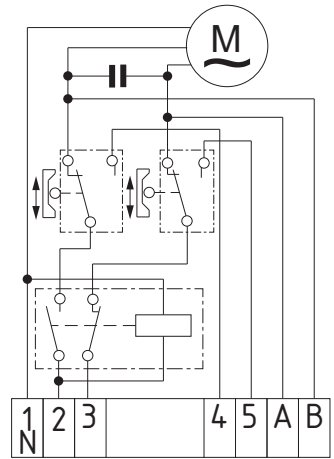

! ADVICE

The add-on board with the single wire control is wired at factory. Never change the internal wiring. Observe the wiring diagram inside the actuator cover.

5.3.10 Parallel relay (230 V AC only)

The integrated relay makes it possible to run several actuators in parallel mode over one switching contact.

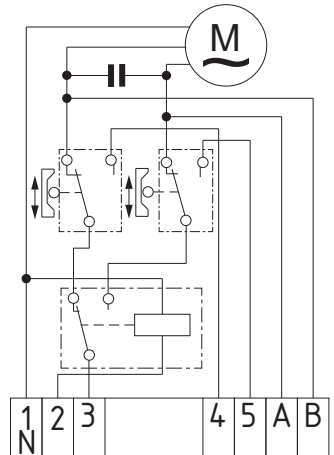
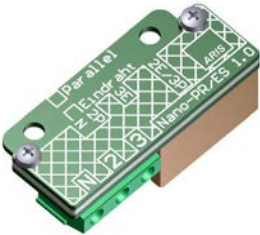

! ADVICE

The add-on board with the parallel relay is wired at factory. Never change the internal wiring. Observe the wiring diagram inside the actuator cover.

5.3.11 Power supply 24 V DC (Special edition)

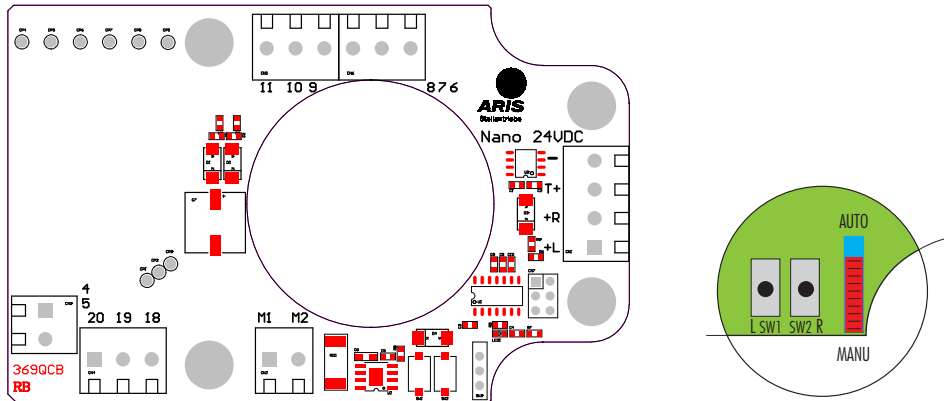

5.3.11.1 Service switch

Use the service switch to perform adjustment and service works on the actuator. For this, terminal T+ must hold a direct current of 24 V DC.

Operation:

Set the sliding switch to „MANU“ (manual operation). The actuator can now be moved left with the button „L SW1“ (position „L“) or right with the button „R SW2“ (position „R“). For operation via an external controller set the sliding switch to „AUTO“. The buttons „L SW1“ and „R SW2“ are without function now.

! ADVICE

The actuating time of an actuator with direct current motor changes load dependant. The indicated actuating time refers to an actuator load with the indicated torque (see name plate).

6. Required customer information

6.1 Extraordinary situations

Run frequent testings during operation. Observe especially:



- Intended use of the actuator (chapter 3.1);
- unusual noise, heavy vibration or high temperatures;
- check screws for tight seat;
- check cable entries, cable glands and blank plugs for tight seat and possible leakiness;
- condition of electric wires.

If failure appear, set the actuator out of order and correct the error.

! ADVICE

If you can not correct the error, contact an ARIS service person.
More information under: www.stellantriebe.de

6.2 Troubleshooting and repair

 WARNING	<p>Hazardous voltage: Possible stroke!</p> <ul style="list-style-type: none">• Troubleshooting and repair only by experts!• Cut off voltage before opening the actuator.
 CAUTION	<p>Moving parts at built-on valves: Possible bruise!</p> <ul style="list-style-type: none">• Troubleshooting and repair only by experts!
 ADVICE	<p>We recommend a repair at the ARIS factory. More information under: www.stellantriebe.de</p>

7. Maintenance

7.1 Service

ARIS actuators of type Nano have a lifetime lubrication and are generally maintenance-free.

7.2 Accessories

No special tools are required for installation.

7.3 Spare parts

 ADVICE	<p>Order spare parts at aris@stellantriebe.de any time. Please always state the serial number of the actuator.</p>
---	---

ARIS Stellantriebe GmbH
Rotter Viehtrift 9
53842 Troisdorf / Germany

www.stellantriebe.de

Tel.: +49 2241 25186-0
Fax: +49 2241 25186-99
aris@stellantriebe.de



Manual for

ARIS Microprocessor- Controller PMR-Nano

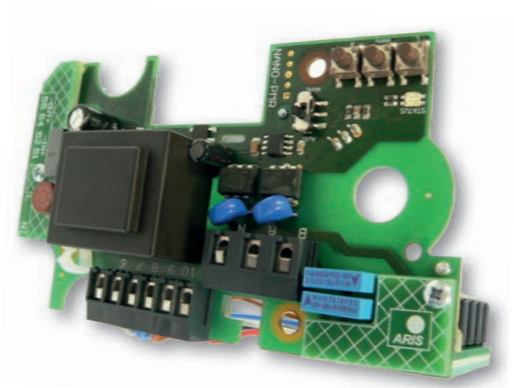

Table of content

Intended use	21
Electrical connection.....	21
Wiring diagram	22
General information	23
Operating controls and indicators	24
Setting up stop positions and potentiometer	24
Programming	25
Technical data.....	29
Declaration of incorporation.....	30

Intended use

ARIS microprocessor controllers, series PMR-Nano, are used for activating ARIS actuators. They are integrated in the actuator housing. PMR-Nano series microprocessor controllers position the actuator based on a reference input (set point). The PMR controller compares the preset set point with the current position of the actuator (actual value). In case the values differ from each other, the actuator is moved to the position specified by the set point. The actual value is determined by a potentiometer, integrated in the actuator.

Electrical connection

Protective measures shall be implemented in accordance with VDE (Association of German Electrotechnical Engineers) and EVU (Electricity Board) regulations. In particular, VDE Regulation 0105 "Working on Live Components" shall be followed.

For electrical installation, make sure to follow the enclosed wiring diagram.

Supply lines to microprocessor controller and actuator must meet the conductor cross-section as specified in the VDE regulations.

For low voltages (set point/actual value signalling cable) use **shielded** conductors of minimum cross-section 0.5 sq.mm. and maximum length of 1000 m.

Make sure to connect one end of the shielding to the housing mass (earthing terminal).

Never attempt to modify the internal wiring of the actuator.



ADVICE

Never attempt to modify the internal wiring of the actuator.

Wiring diagram (Built-in version)

- KM Terminal strip for microprocessor controller
- M Actuator motor
- SL Limit switch, CCW rotation
- SR Limit switch, CW rotation
- R1 Potentiometer for actual value

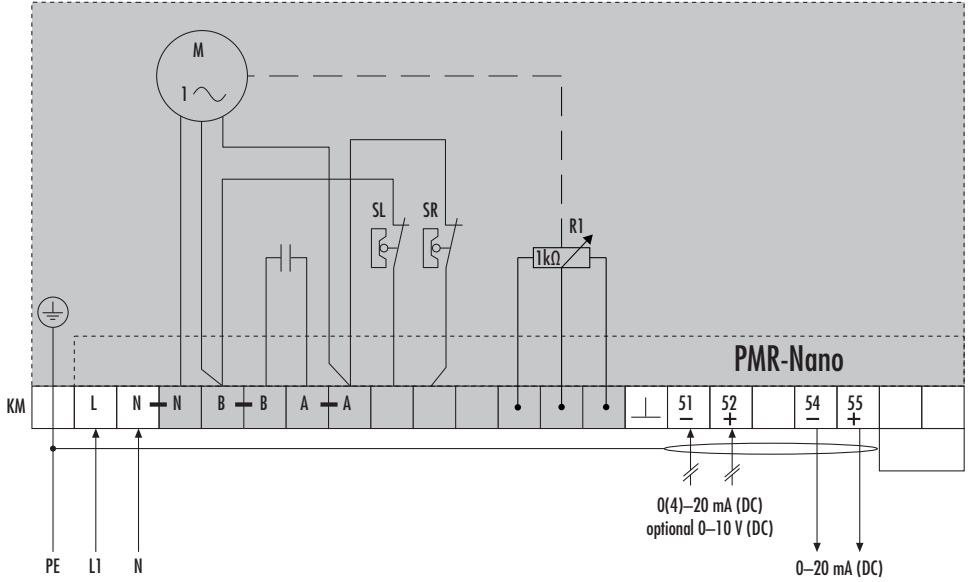

Internal wiring (do not modify!)

External control and wiring

Circuit board

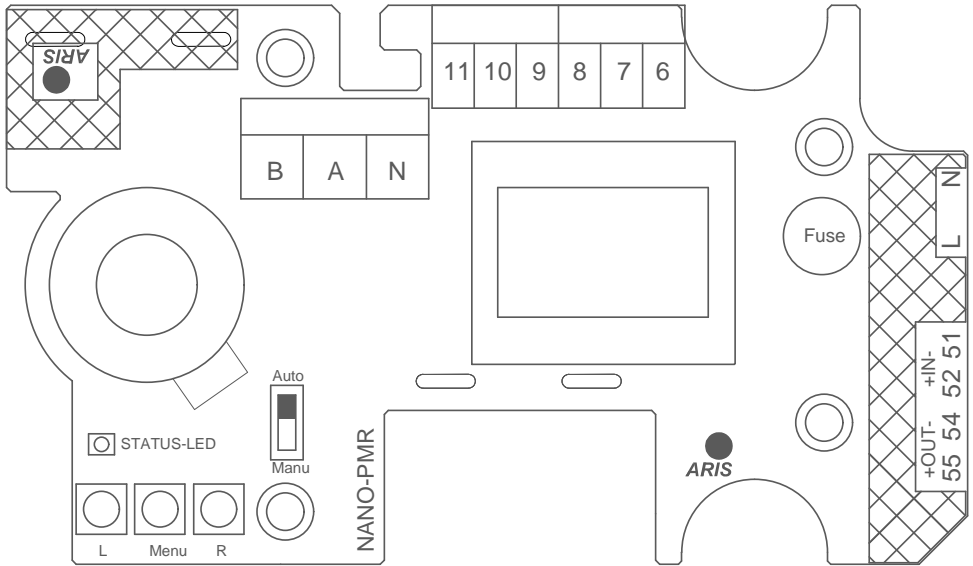

General information

This product is a controller for activation with standard signals. The PMR-Nano control board converts the standard signal in CW or CCW motor activation.

! ADVICE

Position limit switches and potentiometer are not preset upon delivery from factory.

According to the actuated fitting it is necessary to set position limit switches and potentiometer to the regulating distance (max. 90° at the output shaft of the actuator).

! ADVICE

Controller is delivered un-programmed from factory.

Through programming, set points must be assigned to the controller for the stop positions within the range of 0° and 90° (min. difference 18°). Once programming is completed, the positions within the range of the stop positions are approached as activated.

Operating controls and indicators

Status LED

(upper) green
(lower) red



Controller not programmed
(Delivery condition or after reset)

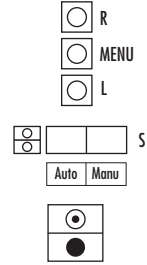

MANU (manual mode)

- Button LEFT: Actuator moving to the left (CCW)
- Button MENU: Activation > 5s ▶ Change in to programming mode
- Button RIGHT: Actuator moving to the right (CW)

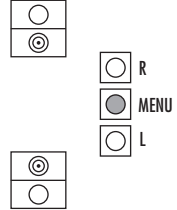

AUTO (automatic mode)

- Buttons : No function
- LED indicator
 - Actuator moving to the left (CCW)
 - Actuator moving to the right (CW)
 - Position reached

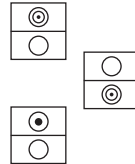

Setting up stop positions and potentiometer

1. Set sliding switch **S** on PMR-Nano controller to **MANU** (manual).
2. Move the actuator with button **R** to the desired right (CW) stop position.
3. Set the respective control cam **R** for the position limit switch **SR** * in the sense of rotation of the control camshaft, so that switch **SR** is activated.
4. Move the actuator with button **L** to the desired left (CCW) stop position
5. Set the respective control cam **L** for the position limit switch **SL** * in the sense of rotation of the control camshaft, so that switch **SL** is activated.
6. Move the actuator with button **R** again to the desired right (CW) stop position.

With it, setting of stop positions and potentiometer is completed.

* see page 11 in manual for actuators of Nano series.

● Leuchtend	Bright	○ Dunkel	Dark	◐ Langsam blinkend	Slowly flashing	◑ Schnell blinkend	Fast flashing
-------------	--------	----------	------	--------------------	-----------------	--------------------	---------------

Programming

- Before you start programming, setting of stop positions and potentiometer must be completed.
- Full programming must run through. Programming of single items, e.g. only actual values, is not possible.

Adjustment of set points/limit positions

- Allocation of limit positions to set points can be done via internally preset set points or externally applied set points.

1. Set sliding switch **S** on the PMR-Nano controller to **MANU** (manual).



2. Pressing the **MENU** key for 5 seconds you enter the programming mode and you will see the following short flashing signal on the LED indicator.



3. Move to the left limit stop position by activating the **L** button.



4. Confirm the position by activating the **MENU** button.



5. By activating buttons **L** or **R** you are able to allocate a corresponding set point to this limit stop position, which is visible by a color change of the LED.

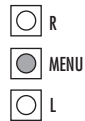

Left set point 0mA



4mA



20mA



externally applied
set point

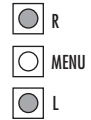

Change with button L / R

6. Confirm selected set point with the **MENU** button



7. You will see the following short flashing signal on the LED indicator.



8. Move to the right limit stop position by activating the **R** button.



9. Confirm the position by activating the **MENU** button.



10. By activating buttons **L** or **R** you are able to allocate a corresponding set point to this limit stop position, which is visible by a color change of the LED.



Right set point 0mA



4mA



20mA



externally applied
set point



Change with button L / R



Depending on the set point allocated to the left limit stop position, only logic settings are possible.



11. Confirm selected set point with the **MENU** button



Setting up actual value output

12. By activating buttons **L** or **R** you select a corresponding actual value output, which is visible by a color change of the LED.

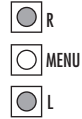

4..20mA



0..20mA



interchanging

Change with buttons **L / R**



13. Confirm selected actual value range by activating the **MENU** button.

Setting for actual value allocation to limit stop positions:

14. By activating buttons **L** or **R** you allocate 0(4)mA to the corresponding limit stop position.



Left end position 0/4mA



Right end position 0/4mA



Change with buttons **L / R**



15. Confirm selected actual value by activating the **MENU** button



With it, programming is completed.

You see the following flashing signal on the LED indicator.



To enter the automatic mode, move the sliding switch **S** to **AUTO**.



In case no external set point is present, the actuator moves to 0/4mA position!

By set point presetting 0(4) up to 20mA it is now possible to position the actuator as programmed.

RESET-OPTION

Deletes the stored data

- With the controller in idle state keep the **MENU** button in **MANU** mode pressed



- Switch on controller, keep **MENU** button pressed for approx. 5s
- LED lights up in red ▶ Controller is initialized
- LED changes to
- Let button go

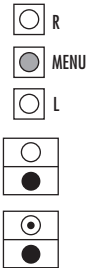

Technische Daten

Power supply:

230 V \pm 10%, 50/60 Hz

Special voltages/frequencies see nameplate

Set point input:

- 0 (4) to 20 mA (DC)
 - Burden 250 Ω
 - Overload protection 630 mA
 - Reverse battery protection up to -630 mA.

ESD protection, input filter, resolution: 10 bit

Actual value output:

Optional limits between 0 and 20 mA (DC)

Current source, max. burden 500 Ω

Resolution: 10 bit

Subject to technical changes.



Declaration of Incorporation of partly completed machinery

according
EU directive 2006/42/EC Annex II B „Machinery Directive“

Herewith we declare, that the below mentioned incomplete machinery

Product description:	Electrical actuator
Product Types:	nano and identical

Fulfills the basic requirements of the annex I of the directive 2006/42/EC, if it applies to the appropriate order:
1.1.2c,e; 1.1.3; 1.1.5; 1.3.4; 1.5.1; 1.5.2; 1.5.4; 1.5.5; 1.5.6; 1.5.8; 1.5.9; 1.5.11; 1.6.1; 1.6.4; 1.7.3; 1.7.4

The following harmonized standards were applied:
DIN EN ISO 12100:2011-03 („Safety of machinery“)

The product is a partly completed machinery accordance with Article 2 letter g of the Directive 2006/42/EG. The special technical documents according to annex VII part B have been created. For reasonable requests these documents can be sent electronically to the responsible authorities.

Regarding the outgoing electrical hazards of the partly completed machinery, the safety objectives of directive 2006/95/EC ("Low Voltage Directive") are complied with in accordance with Annex I No. 1.5.1 of Directive 2006/42/EC. Applied harmonized standard:

DIN EN 61010-1:2011-07 ("Safety requirements for electrical equipment for measurement, control, Control and laboratory use ")

The initial operation of this incomplete machinery is only permitted, if it is approved that the facility or machinery in which it will be installed corresponds to the EC directive 2006/42/EC, if it applies.

Authorized representative for collection of relevant technical documents:

Claudio Usai
Quality and product safety
ARIS Stellantriebe GmbH
Rotter Viehtrift 9
D-53842 Troisdorf

This declaration is invalid if the machinery is changed or rebuilt in a manner it was not designed for.

Troisdorf, 01. June 2014

C. Usai (Quality and product safety)

ARIS Stellantriebe GmbH
www.stellantriebe.de

Rotter Viehtrift 9
D-53842 Troisdorf

Telefon +49(0)2241-25186-0
Telefax +49(0)2241-25186-99

ARIS Stellantriebe GmbH
Rotter Viehtrift 9
53842 Troisdorf / Germany

www.stellantriebe.de

Tel.: +49 2241 25186-0
Fax: +49 2241 25186-99
aris@stellantriebe.de

